

Regione Piemonte
Recupero spazi immobile vincolato
via Giolitti 36 - Torino
Fase 5
Museo Regionale di Scienze Naturali



ALLEGATO A - TAVOLE DI PROGETTO

FORNITURA E POSA DI CASSETTIERE METALLICHE DI SERIE PER IL DEPOSITO VISITABILE
DI PALEONTOLOGIA DEL MUSEO REGIONALE DI SCIENZE NATURALI DI TORINO

9 Giugno 2021



CASSETTIERA A

quadrata cm 70 x 70 ca

cassetti portata 70-80 Kg (h 7,5 - 10 - 12,5 - 15 cm)

cassetti portata 200 Kg (h 20 - 30 cm)

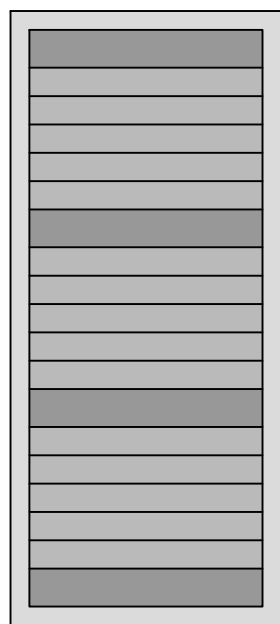

CASSETTIERA A1

15 cassetti 7.5 cm
4 cassetti 10 cm
h totale 162.5 cm

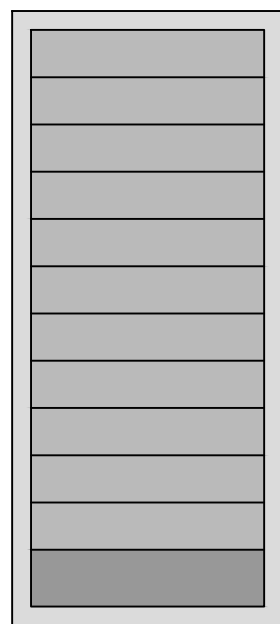

CASSETTIERA A2

11 cassetti 12.5 cm
1 cassetto 15 cm
h totale 162.5 cm

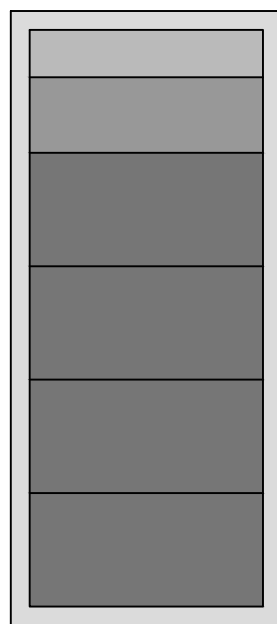

CASSETTIERA A3

1 cassetto 12.5 cm
1 cassetto 20 cm
4 cassetti 30 cm
h totale 162.5 cm

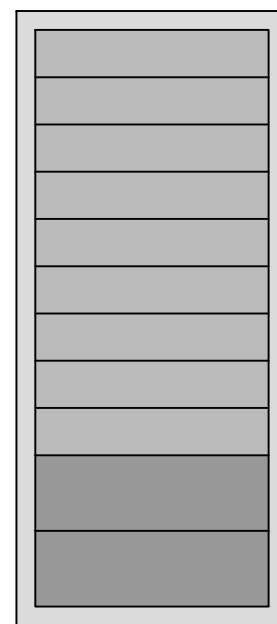

CASSETTIERA A4

9 cassetto 12.5 cm
2 cassetto 20 cm
h totale 162.5 cm

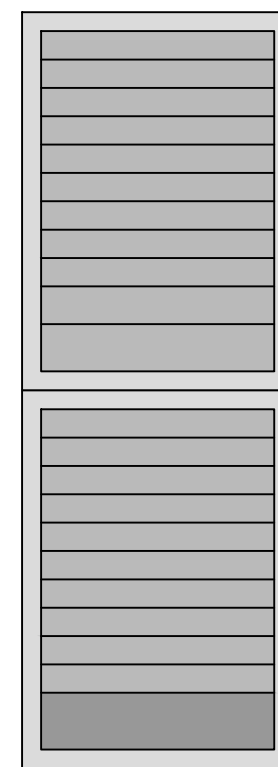

CASSETTIERA A5

19 cassetti 7.5 cm
1 cassetto 10 cm
1 cassetto 12,5 cm
1 cassetto 15 cm
h totale 200 cm

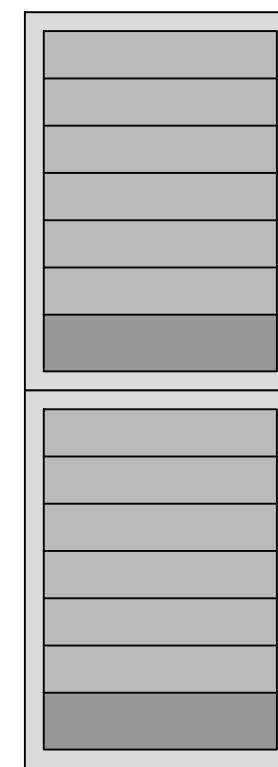

CASSETTIERA A6

12 cassetti 12.5 cm
2 cassetti 15 cm
h totale 200 cm



CASSETTIERA TIPO B

cassettiere rettangolari
140 X 70 cm ca.
Portata cassetti 200 Kg

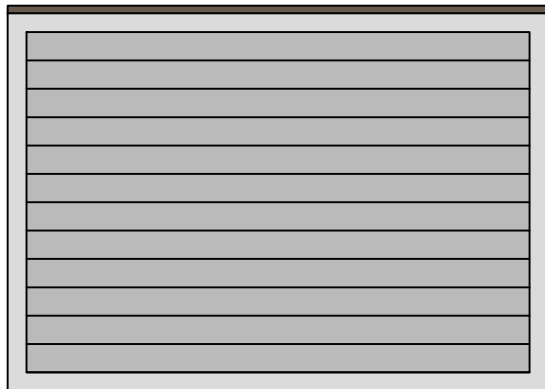

CASSETTIERA B1

12 cassetti 7.5 cm
h totale 100 cm ca.

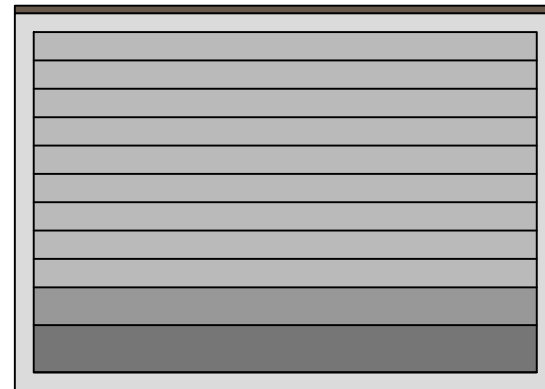

CASSETTIERA B2

9 cassetti 7.5 cm
1 cassetto 10 cm
1 cassetto 12.5 cm
h totale 100 cm ca.

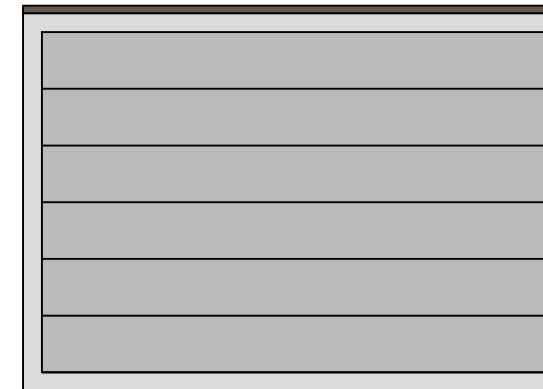

CASSETTIERA B3

6 cassetti 15 cm
h totale 100 cm ca.

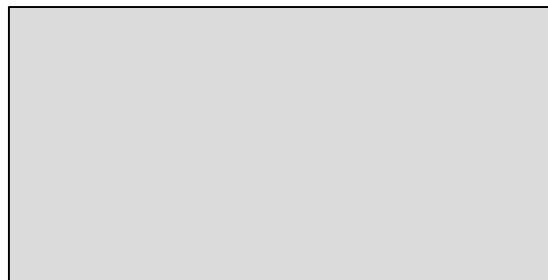

CASSETTIERA TIPO B

cassettiere rettangolari
140 X 70 cm ca.
Portata cassetti 200 Kg

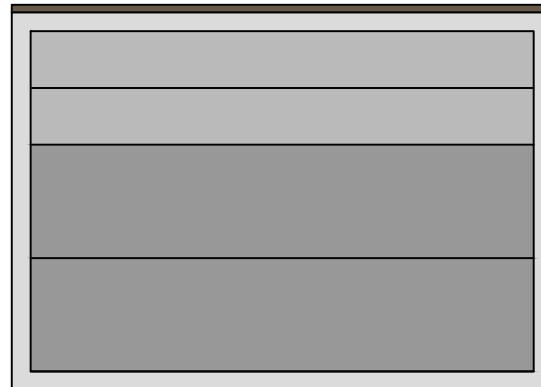

CASSETTIERA B4

2 cassetti 15 cm
2 cassetti 30 cm
h totale 100 cm ca.

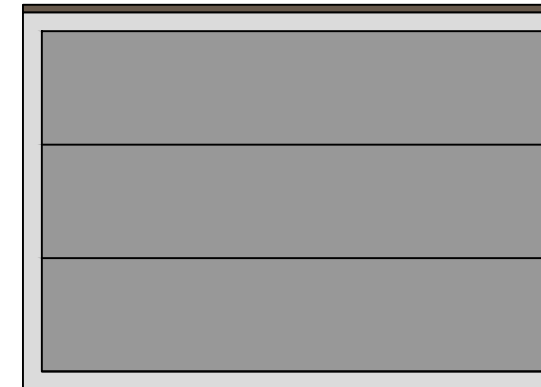

CASSETTIERA B5

3 cassetti 30 cm
h totale 100 cm ca.

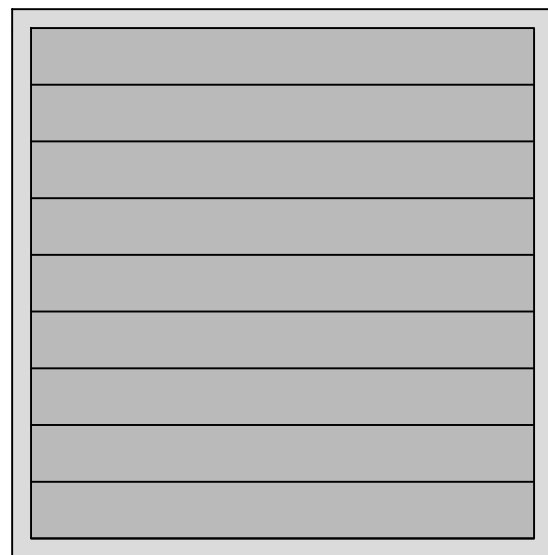

CASSETTIERA B6

9 cassetti 15 cm
h totale 145 cm

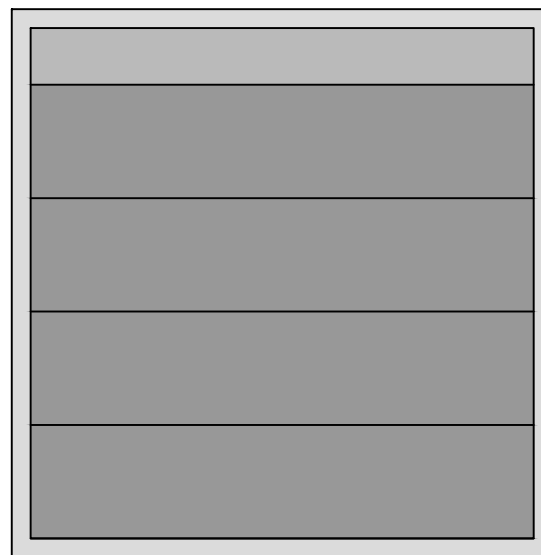

CASSETTIERA B7

1 cassetto 15 cm
4 cassetti 30 cm
h totale 145 cm

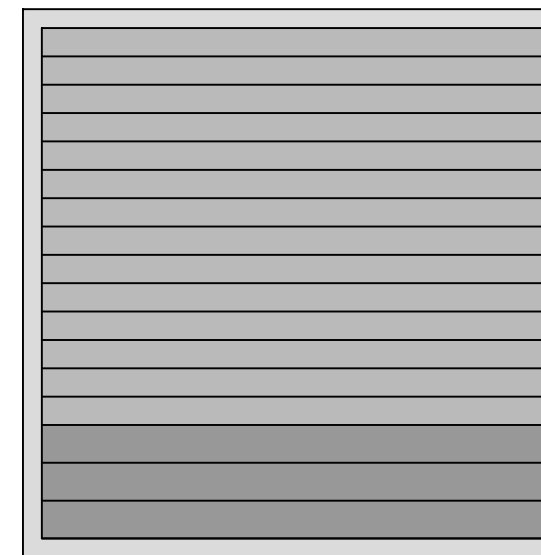

CASSETTIERA B8

14 cassetti 7.5 cm
3 cassetti 10 cm
h totale 145 cm

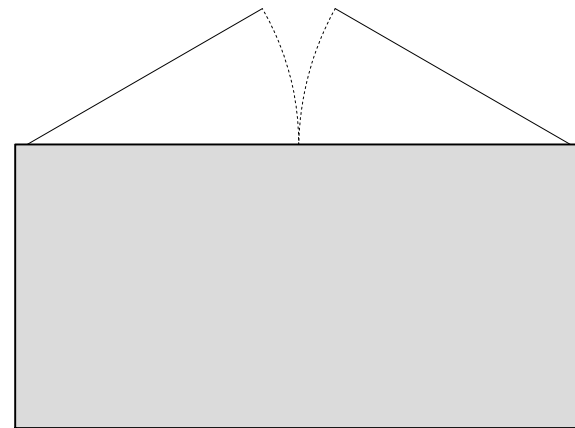

CASSETTIERA CON ANTE TIPO C

cassettiere rettangolari
150 X 75 cm ca.
Portata piani 200Kg

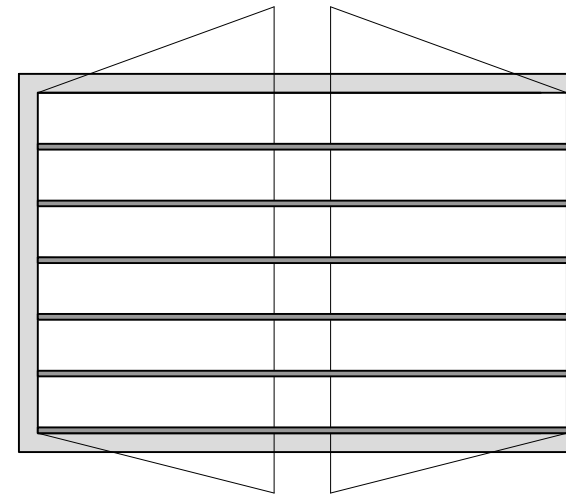

CASSETTIERA CON ANTE C

8 ripiani estraibili ogni 10/15 cm circa
h totale 100 cm